

## FEATURES

- **High Current Transfer Ratio**  
**CNY17-1, 40 to 80%**  
**CNY17-2, 63 to 125%**  
**CNY17-3, 100 to 200%**  
**CNY17-4, 160 to 320%**
- **Breakdown Voltage, 5300 VAC<sub>RMS</sub>**
- **Field-Effect Stable by TRIOS™**
- **Long Term Stability**
- **Industry Standard Dual-in-Line Package**
- **Underwriters Lab File #E52744**
-  **VDE #0884, Available with Option 1**

## DESCRIPTION

The CNY17 is an optically coupled pair consisting of a Gallium Arsenide infrared emitting diode optically coupled to a silicon NPN phototransistor.

Signal information, including a DC level, can be transmitted by the device while maintaining a high degree of electrical isolation between input and output.

The CNY17 can be used to replace relays and transformers in many digital interface applications, as well as analog applications such as CRT modulation.

## Maximum Ratings (T<sub>A</sub>=25°C)

### Emitter

Reverse Voltage ..... 6 V  
 Forward Current ..... 60 mA  
 Surge Current (t ≤ 10 μs) ..... 2.5 A  
 Power Dissipation ..... 100 mW

### Detector

Collector-Emitter Breakdown Voltage ..... 70 V  
 Emitter-Base Breakdown Voltage ..... 7 V  
 Collector Current ..... 50 mA  
 Collector Current (t < 1 ms) ..... 100 mA  
 Power Dissipation ..... 150 mW

### Package

Isolation Test Voltage (Between emitter & detector referred to climate DIN 40046, part 2, Nov. 74) ..... 5300 VAC<sub>RMS</sub>  
 Creepage Distance ..... ≥ 7 mm  
 Clearance Distance ..... ≥ 7 mm  
 Isolation Thickness between Emitter and Detector ..... ≥ 0.4 mm  
 Comparative Tracking Index per DIN IEC 112/ VDE0303, part 1 ..... 175  
 Isolation Resistance  
 V<sub>IO</sub> = 500 V, T<sub>A</sub> = 25°C ..... ≥ 10<sup>12</sup> Ω  
 V<sub>IO</sub> = 500 V, T<sub>A</sub> = 100°C ..... ≥ 10<sup>11</sup> Ω  
 Storage Temperature ..... -55°C to +150°C  
 Operating Temperature ..... -55°C to +100°C  
 Junction Temperature ..... 100°C  
 Soldering Temperature (max. 10 s, dip soldering; distance to seating plane ≥ 1.5 mm) ..... 260°C

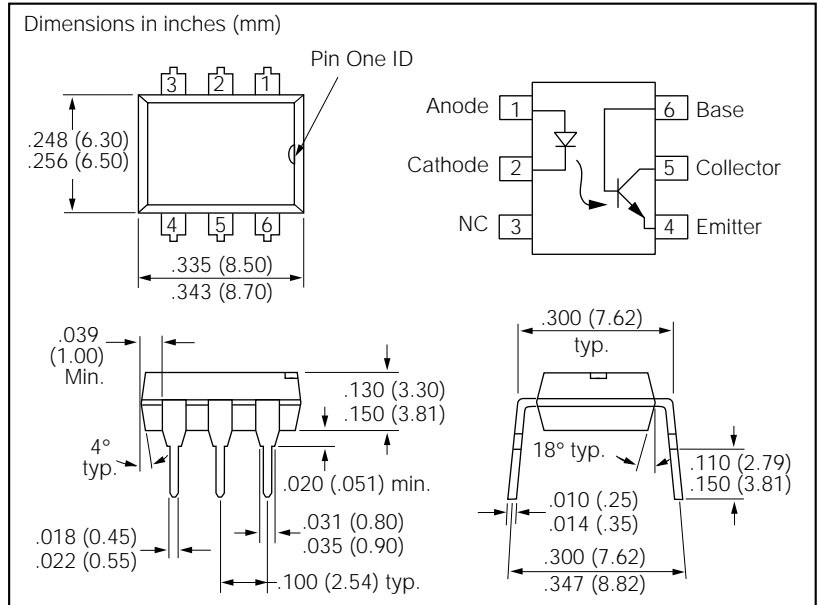

## Characteristics (T<sub>A</sub>=25°C)

|                                      | Symbol  |                   | Unit           | Condition  |
|--------------------------------------|---|-------------------|----------------|--|
| <b>Emitter</b>                       |   |                   |                |  |
| Forward Voltage                      | V <sub>F</sub>  | 1.25 (≤1.65)      | V              | I <sub>F</sub> = 60 mA   |
| Breakdown Voltage                    | V <sub>BR</sub>                                       | ≥6                | V              | I <sub>R</sub> = 10 mA   |
| Reverse Current                      | I <sub>R</sub>  | 0.01 (≤10)        | μA             | V <sub>R</sub> = 6 V   |
| Capacitance                          |   | 25                | pF             | V <sub>R</sub> = 0 V, f = 1 MHz  |
| Thermal Resistance                   | R <sub>thjamb</sub>                                   | 750               | K/W            |  |
| <b>Detector</b>                      |   |                   |                |  |
| Capacitance                          | C <sub>CE</sub><br>C <sub>CB</sub><br>C <sub>EB</sub> | 5.2<br>6.5<br>7.5 | pF<br>pF<br>pF | V <sub>CE</sub> = 5 V, f = 1 MHz<br>V <sub>CB</sub> = 5 V, f = 1 MHz<br>V <sub>EB</sub> = 5 V, f = 1 MHz |
| Thermal Resistance                   | R <sub>thjamb</sub>                                   | 500               | K/W            |  |
| <b>Package</b>                       |   |                   |                |  |
| Collector-Emitter Saturation Voltage | V <sub>CEsat</sub>                                    | 0.25 (≤0.4)       | V              | I <sub>F</sub> = 10 mA, I <sub>C</sub> = 2.5 mA  |
| Coupling Capacitance                 | C <sub>C</sub>  | 0.6               | pF             |  |

**Current Transfer Ratio and Collector-Emitter Leakage Current by dash number ( $T_A=25^\circ\text{C}$ )**

|  | -1              | -2              | -3               | -4               | Unit |
|--|-----------------|-----------------|------------------|------------------|------|
| $I_C/I_F$ at $V_{CE}=5\text{ V}$<br>( $I_F=10\text{ mA}$ )                     | 40-80           | 63-125          | 100-200          | 160-320          | %    |
| $I_C/I_F$ at $V_{CE}=5\text{ V}$<br>( $I_F=1\text{ mA}$ )                      | 30<br>(>13)     | 45<br>(>22)     | 70<br>(>34)      | 90<br>(>56)      | %    |
| Collector-Emitter Leakage Current<br>( $V_{CE}=10\text{ V}$ )<br>( $I_{CEO}$ ) | 2 ( $\leq 50$ ) | 2 ( $\leq 50$ ) | 5 ( $\leq 100$ ) | 5 ( $\leq 100$ ) | nA   |

**Figure 1. Linear Operation (without saturation)**

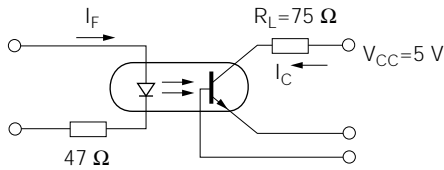

$I_F=10\text{ mA}$ ,  $V_{CC}=5\text{ V}$ ,  $T_A=25^\circ\text{C}$

|                   |           |     |               |
|-------------------|-----------|-----|---------------|
| Load Resistance   | $R_L$     | 75  | $\Omega$      |
| Turn-On Time      | $t_{ON}$  | 3.0 | $\mu\text{s}$ |
| Rise Time         | $t_R$     | 2.0 | $\mu\text{s}$ |
| Turn-Off Time     | $t_{OFF}$ | 2.3 | $\mu\text{s}$ |
| Fall Time         | $t_f$     | 2.0 | $\mu\text{s}$ |
| Cut-off Frequency | $f_{CO}$  | 250 | kHz           |

**Figure 2. Switching Operation (with saturation)**

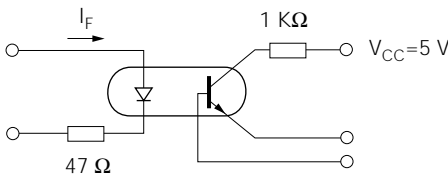

|               |           | -1<br>( $I_F=20\text{ mA}$ ) | -2 and -3<br>( $I_F=10\text{ mA}$ ) | -4<br>( $I_F=5\text{ mA}$ ) |               |
|---------------|-----------|------------------------------|-------------------------------------|-----------------------------|---------------|
| Turn-On Time  | $t_{ON}$  | 3.0                          | 4.2                                 | 6.0                         | $\mu\text{s}$ |
| Rise Time     | $t_R$     | 2.0                          | 3.0                                 | 4.6                         | $\mu\text{s}$ |
| Turn-Off Time | $t_{OFF}$ | 18                           | 23                                  | 25                          | $\mu\text{s}$ |
| Fall Time     | $t_f$     | 11                           | 14                                  | 15                          | $\mu\text{s}$ |

**Figure 3. Current transfer ratio versus diode current ( $T_A=-25^\circ\text{C}$ ,  $V_{CE}=5\text{ V}$ )**

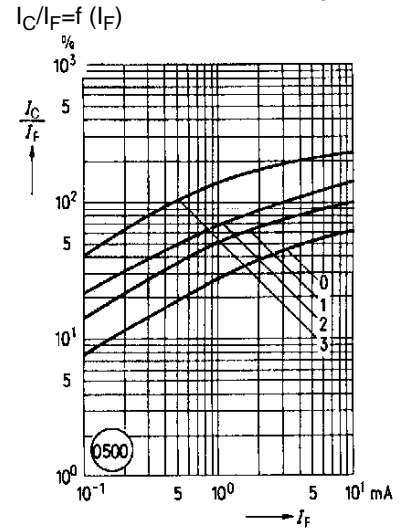

**Figure 4. Current transfer ratio versus diode current ( $T_A=0^\circ\text{C}$ ,  $V_{CE}=5\text{ V}$ )**

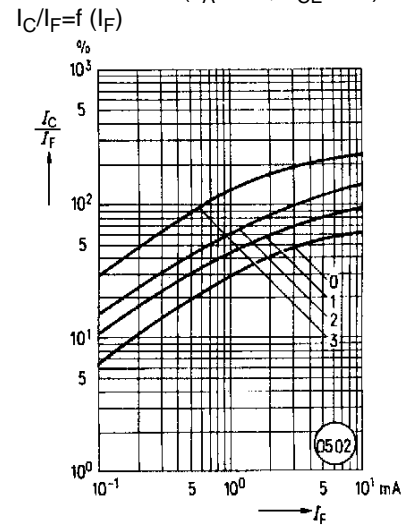

**Figure 5. Current transfer ratio versus diode current ( $T_A=25^\circ\text{C}$ ,  $V_{CE}=5\text{ V}$ )**

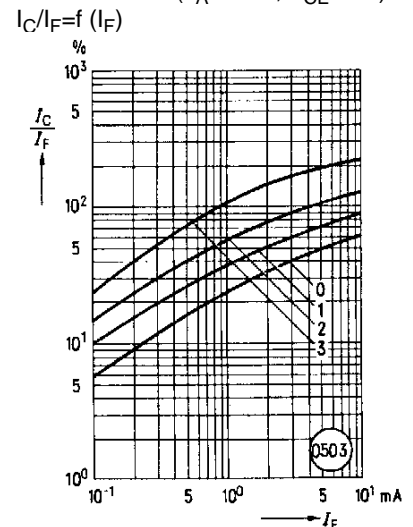

**Figure 6. Current transfer ratio versus diode current** ( $T_A=50^\circ\text{C}$ )  
 $V_{CE}=5\text{ V}$ ,  $I_C/I_F=f(I_F)$

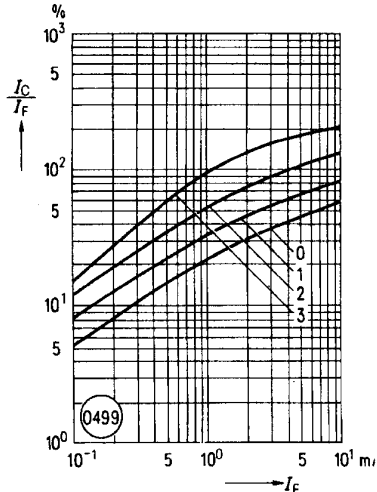

**Figure 7. Current transfer ratio versus diode current** ( $T_A=75^\circ\text{C}$ )  $V_{CE}=5\text{ V}$

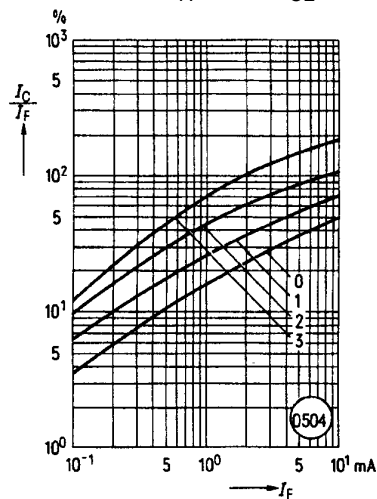

**Figure 8. Current transfer ratio versus temperature** ( $I_F=10\text{ mA}$ ,  $V_{CE}=5\text{ V}$ )  
 $I_C/I_F=f(T)$

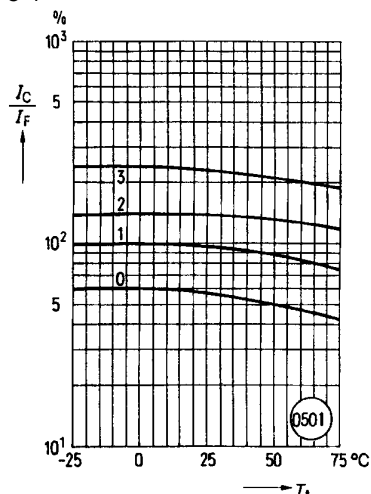

**Figure 9. Transistor characteristics** ( $B=550$ ) CNY17-3, -4  $I_C=f(V_{CE})$   
 $(T_A=25^\circ\text{C}, I_F=0)$

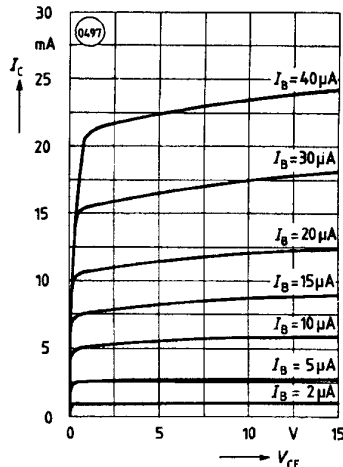

**Figure 10. Output characteristics** CNY17-3, -4 ( $T_A=25^\circ\text{C}$ )  $I_C=f(V_{CE})$

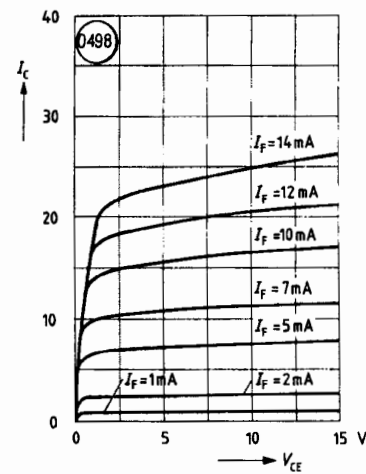

**Figure 11. Forward voltage**  $V_F=f(I_F)$

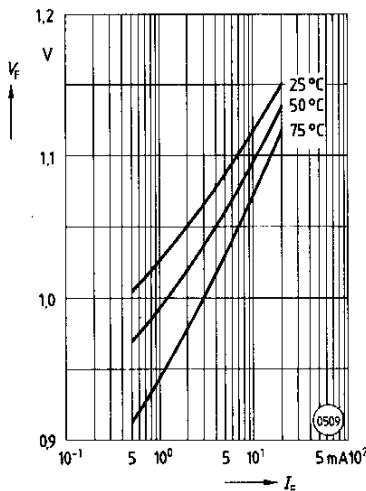

**Figure 12. Collector emitter off-state current**  $I_{CEO}=f(V, T)$  ( $T_A=25^\circ\text{C}, I_F=0$ )

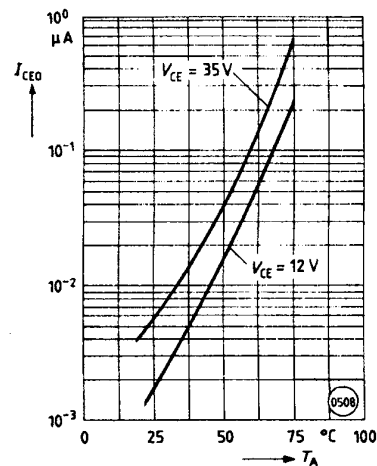

**Figure 13. Saturation voltage versus collector current and modulation depth** CNY17-1  $V_{CEsat}=f(I_C)$  ( $T_A=25^\circ\text{C}$ )

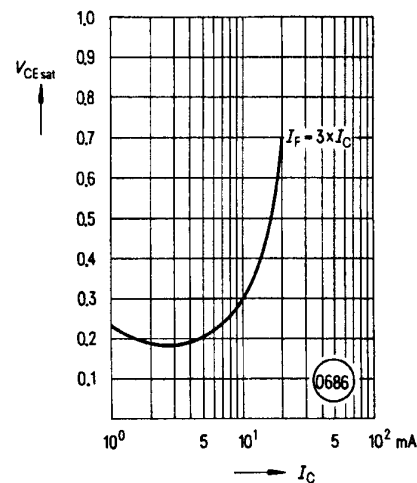

**Figure 14. Saturation voltage versus collector current and modulation depth** CNY17-2  $V_{CEsat}=f(I_C)$   
 $(T_A=25^\circ\text{C})$

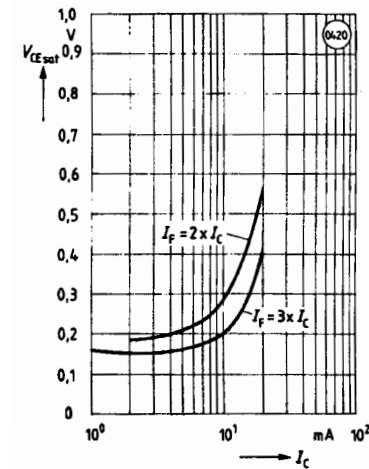

**Figure 15. Saturation voltage versus collector current and modulation depth CNY17-3**  $V_{CEsat}=f(I_C)$  ( $T_A=25^\circ\text{C}$ )

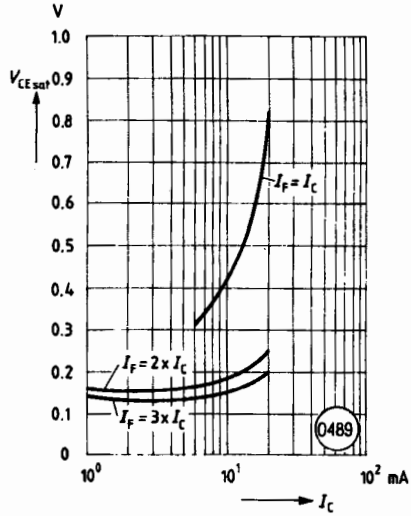

**Figure 16. Saturation voltage versus collector current and modulation depth CNY17-4**  $V_{CEsat}=f(I_C)$  ( $T_A=25^\circ\text{C}$ )

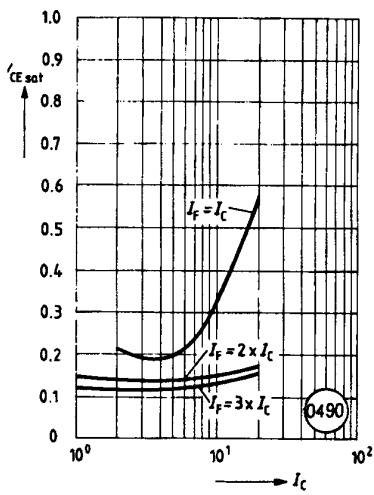

**Figure 17. Permissible pulse load**  $D=\text{parameter}$ ,  $T_A=25^\circ\text{C}$ ,  $I_F=f(t_p)$

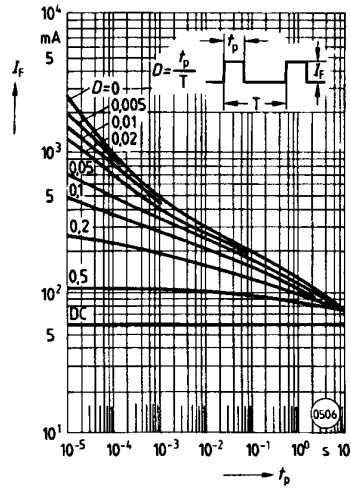

**Figure 18. Permissible power dissipation transistor and diode**  $P_{tot}=f(T_A)$

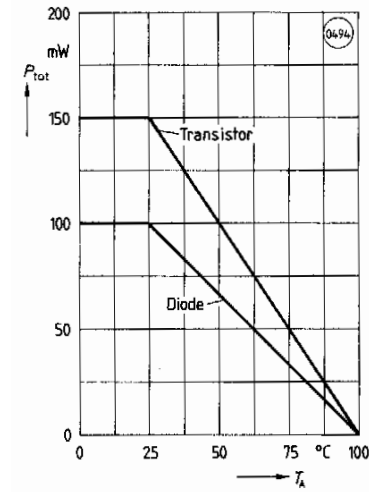

**Figure 19. Permissible forward current**  $P_{tot}=f(T_A)$

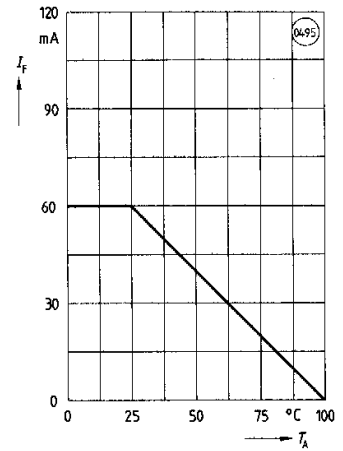

**Figure 20. Transistor capacitance**  $C=f(V_O)$  ( $T_A=25^\circ\text{C}$ ,  $f=1$  MHz)

