

Monsanto

OPTICALLY ISOLATED LOGIC GATE

MCL601 MCL611

PRODUCT DESCRIPTION

The MCL601 and MCL611, are optically isolated logic gates in an 8-lead DIP package. A GaAs LED radiates infrared light onto a high speed photodiode detector, thus providing electrical isolation of ± 2000 V between input and output. A differential comparator amplifies the photodiode signal, and a Schmitt trigger improves noise immunity by providing threshold and hysteresis. A standard open collector circuit on the output offers normal current sinking capability. The LED drive current requirement matches either mode of logic loading. The output is compatible to most logic systems. The MCL601 has a 0.1 MHz data rate; the MCL 611 has a 1 MHz data rate.

PACKAGE DIMENSIONS

ALL DIMENSIONS IN INCHES

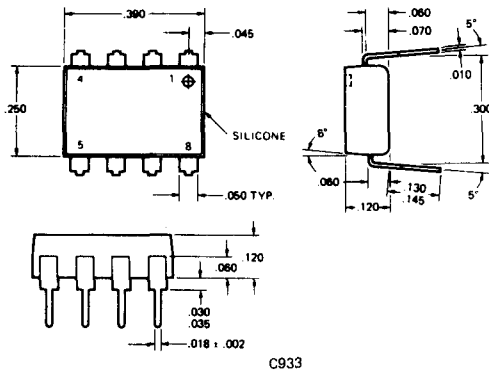

PIN	
1	LED ANODE
2	LED CATHODE
3	N/C
4	N/C
5	OUT
6	GROUND
7	V _{CC}
8	PHOTO DIODE CATHODE

FEATURES

- Compatible TTL input drive load
- Output compatible to TTL, DTL, RTL, CTL, HiNIL
- Single +5 V_{CC} supply required
- High toggle speed, high data rate
- Short transmission delay
- Small 8 pin DIP, two packages fit 16 pin socket
- High isolation between input-output
- High CMRR (Common Mode Rejection Ratio)
- Built-in hysteresis for noise immunity
- Output ORing capability

APPLICATIONS

- Digital logic to digital logic isolator—eliminates spurious grounds
- DC input level sensor—Schmitt trigger toggle
- AC to TTL conversion—square wave shaping
- Line receiver—eliminates CMN and ground loop transients
- Logic level shifter, input-output independent ground systems

SCHEMATIC DIAGRAM

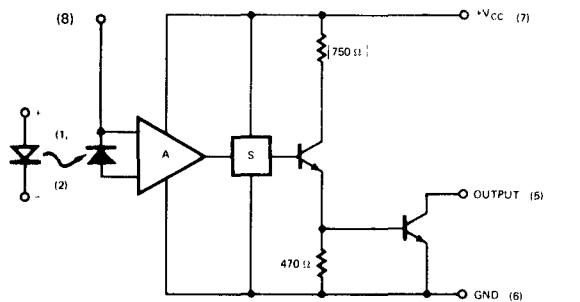

A = Differential amp, comparator
S = Schmitt trigger, threshold hysteresis
Typical Values Shown

SYMBOL

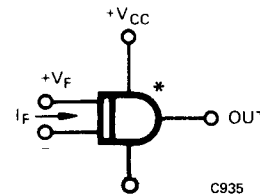

C935
* OPEN COLLECTOR

ABSOLUTE MAXIMUM RATINGS

Storage temperature	-55°C to +150°C
Operating temperature	0°C to +70°C
Lead temperature (Soldering, 10 sec.)	260°C
Input Diode	
Forward DC current	20 mA
Reverse Voltage	3V
Peak forward current (1 μs pulse, 300 pps)	3.0 A
Power dissipation at 25°C ambient	100 mW
Derate linearly from 25°C	1.33 mW/°C
Output Gate	
Power dissipation at 25°C ambient	100 mW
Derate linearly from 25°C	1.33 mW/°C
DC supply current I _{CC}	30 mA
Output collector voltage V _{SS}	15V
V _{CC}	8V
Output current low—I _{OL}	16 mA
Input to output voltage	±2000 V DC

Note: The input is not specified as "HI" or "LOW" as with normal gate units. The input is "ON" or "OFF," set by the current flow through the input LED. Thus the input may be "ON" for logic drive "HI" (pull up load system, Figure 1A) or logic drive "LOW" (pull down load systems, Figure 1B, as in open collector output devices.) See Z plot.

As a convenience of notation, reference will be made to a pull down type load input connected as in Figure 1B. A logical "LOW" is "ON", and a logical "HI" is "OFF".

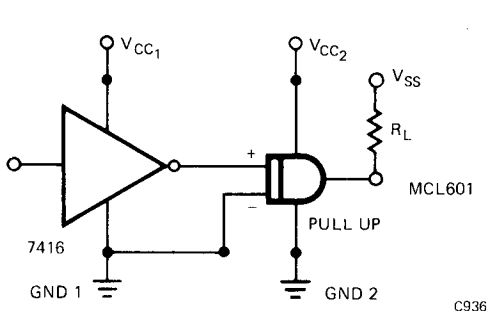

Figure 1A

C936

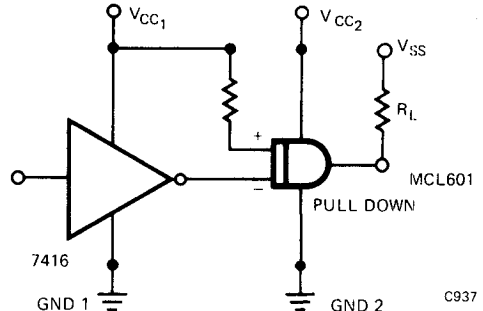

Figure 1B

C937

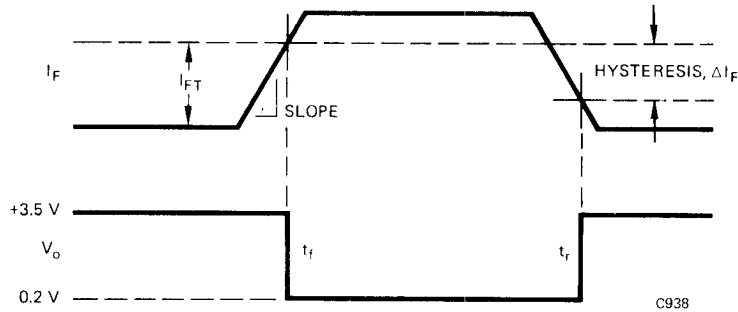

Figure 2A

C938

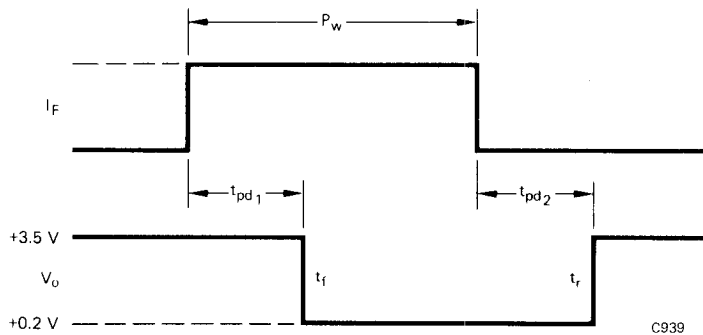

Figure 2B

C939

The MCL input may be driven in series or in parallel with other MCL units, and/or in parallel with other logic units. The input of the MCL has an equivalent unit load (U.L.) rating related to current requirements.

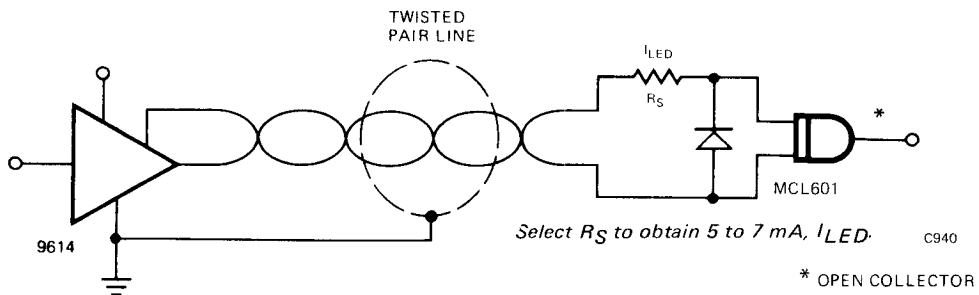

Fig. 3. Line Receiver

C940

RECOMMENDED OPERATING CONDITIONS

PARAMETER	LIMITS			UNITS
	MIN.	TYP.	MAX.	
Supply Voltage V_{CC}	4.5	5.0	5.5	Volts
Operating Free Air Temperature Range	0	25	70	$^{\circ}C$
Normalized Fan Out			20	U.L.
Logic HIGH			20	U.L.
Logic LOW			10	U.L.
Maximum Input Rise and Fall Time	Slope	}	No Restriction	
Minimum Input Rise and Fall Time			See Fig. 2A	
Minimum Pulse Width			least t_{pd}	

ELECTRICAL CHARACTERISTICS (25 $^{\circ}C$)

PARAMETER	SYMBOL	LIMITS			UNITS	TEST CONDITIONS (Note 1)
		MIN.	TYP. (Note 2)	MAX.		
Input Diode						
Forward Voltage	V_F		1.25	1.50	V	$I_F = 20 \text{ mA}$
Forward Voltage Temp Coefficient			-1.8		$\text{mV}/^{\circ}C$	
Reverse Breakdown Voltage	BV_R	3.0	5.5		V	$I_R = 10 \mu A$
Reverse Leakage Current			.001	10	μA	$V_R = 3.0 \text{ V}$
Junction Capacitance	C_J		50		pF	$V_F = 0$
Rise Time	t_r		20		ns	$I_F = 50 \text{ mA}, 50\Omega \text{ system}$
Fall Time	t_f		20		ns	$I_F = 50 \text{ mA}, 50\Omega \text{ system}$
Output						
Output Current HIGH (collector leakage)	I_{OHL}			200	μA	$V_{CC} = 4.5 \text{ V}, I_F = 0 \text{ mA}$ $V_{OH} = 15 \text{ V}$
Output Voltage LOW	V_{OL}		0.2	0.4	Volts	$V_{CC} = 4.5 \text{ V}, I_F = (\text{ON})\text{MAX}$ $I_{OL} = 16 \text{ mA}$
Supply Current HIGH	I_{CCH}		6	15	mA	$V_{CC} = 5.5\text{V}, I_F = 0 \text{ mA}$
Supply Current LOW	I_{CCL}		10	25	mA	$V_{CC} = 5.5\text{V}, I_F = \text{MAX}$

MCL601, 5 mA DRIVE ($V_{CC} = 5 \text{ V}$)

Switching Characteristics (Fig. 2B)

t_{pd} (On)		2	4	μs	$I_F = 3.0 \text{ mA}$
t_{pd} (Off)		2	4	μs	$I_F = 3.0 \text{ mA}$
t_r, t_f			10	ns	$C_L = 25 \text{ pF}, R_L = 280\Omega$
Binary data rate	0.1	0.2		MHz	$I_F = 3.0 \text{ mA}, R_L = 280 \Omega$

Input Diode

I_F (On)		3.0	5.0	mA	
I_F (Off)	0.5	2.0		mA	
ΔI_F (hysteresis)		1.0		mA	
V_F (On)		1.15		V	$I_F = 5.0 \text{ mA}$
V_F (Off)		0.95		V	$I_F = 1.0 \text{ mA}$
Input load equivalent		2		U.L.	

MCL611, 15 mA DRIVE ($V_{CC} = 5 \text{ V}$)

Switching Characteristics (Fig. 2B)

t_{pd} (On) (Fig. 9)		.3	.6	μs	$I_F = 10 \text{ mA}$
t_{pd} (Off)				μs	$I_F = 10 \text{ mA}$
t_r, t_f			10	ns	$C_L = 25 \text{ pF}, R_L = 280\Omega$
Binary data rate	1.0	1.2		MHz	$I_F = 3.0 \text{ mA}, R_L = 280 \Omega$

Input Diode (Fig. 11)

I_F (On)		10	15	mA	
I_F (Off)	2.0	5		mA	
ΔI_F (hysteresis)		5		mA	
V_F (On)		1.1	1.30	V	$I_F = 10 \text{ mA}$
V_F (Off)	1.00	1.1		V	$I_F = 2.5 \text{ mA}$
Input load equivalent		6		U.L.	

ISOLATION

DC Voltage Breakdown	2000		VDC
AC Voltage Limit @ 60 Hz	800		VRMS
Capacitance		1.0	pF
Resistance		10^{12}	Ω

TYPICAL ELECTRO-OPTICAL CHARACTERISTIC CURVES

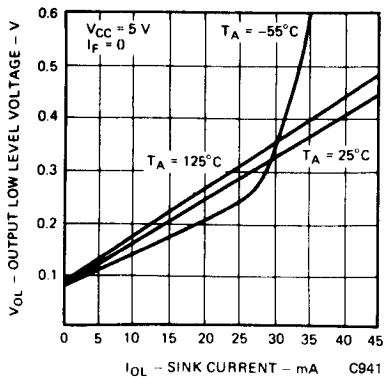

Fig. 4. Low Level Output Voltage vs. Sink Current

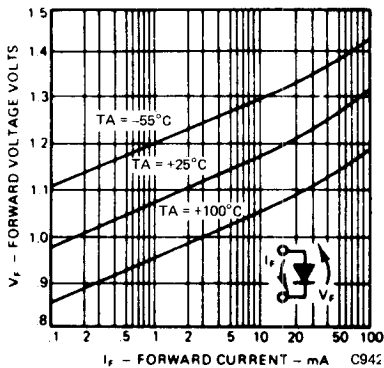

Fig. 5. Forward Voltage vs. Forward Current

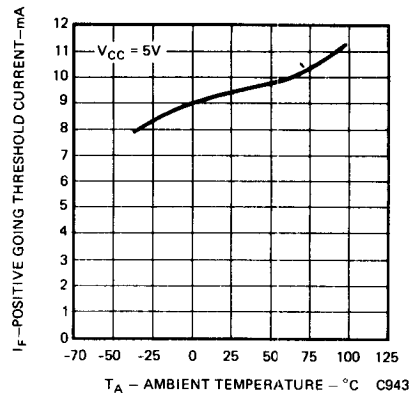

Fig. 6. MCL 611-Positive Going Threshold Current vs. Ambient Temperature

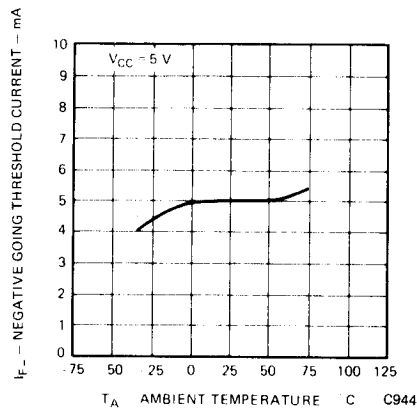

Fig. 7. MCL611-Negative-Going Threshold Current vs. Ambient Temperature

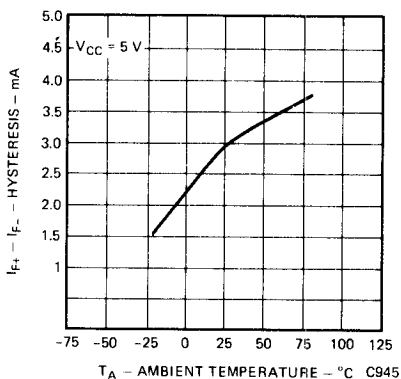

Fig. 8. MCL611-Hysteresis vs. Ambient Temperature

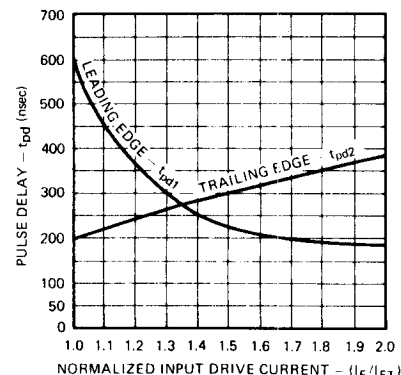

Fig. 9. MCL611-Normalized Input Drive Current vs. Pulse Delay

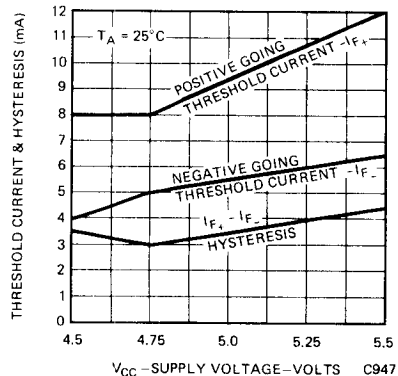

Fig. 10. MCL611-Threshold Current & Hysteresis vs. Supply Voltage

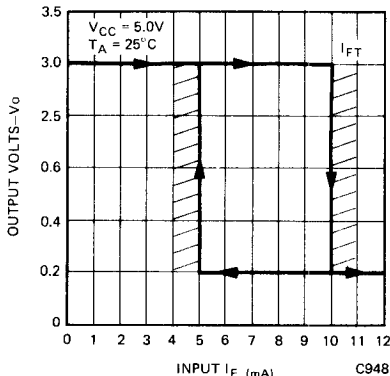

Fig. 11. MCL611-Threshold & Hysteresis of Input/Output

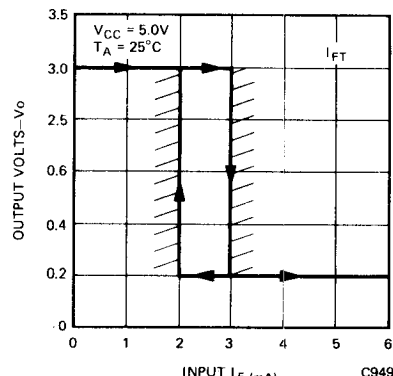

Fig. 12. MCL601-Threshold & Hysteresis of Input/Output

NOTES:

1. For conditions shown as MIN. or MAX., use the appropriate value specified under recommended operating conditions for the applicable device type.
2. Typical limits are at VCC = 5.0 V, 25°C.